

VOGLAUER



cuben
living



LIST OF TYPES

(valid after 2024.07.01)

Please always indicate the following specifications:

MODEL: CL | Vcuben living

WOOD / METAL:



ER | Wild oak rustic black oiled
A | anthracite

LIGHTING:



Lighting
wireless switch



Lighting
with switch

COVER MATERIALS:

(please specify code and colour designation)

LEATHER MONTAN:

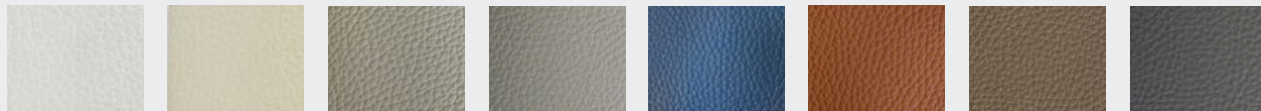

LR | reinweiß LW | sahne LO | coco LK | kiesel LA | azurblau LV | cognac LM | stone LP | cenere



LY | ziegelrot LU | caffè LL | oceano LX | burgundy LN | anthrazit LZ | army green LS | schwarz LT | testa di moro

LODEN:



MG | grauweiß MB | basaltgrau MT | tundra Braun

VINTAGE:

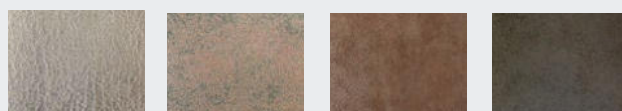

VQ | quarz VB | bronze VT | terra VM | moor

CURL:



CN | natur CM | melange CS | steele CO | olive CW | warm grey

CHALET:



CP | perl CK | kiesel



CT | timber CD | dark blue CR | royal red CB | black



CU | umbragrau CV | vidalschwarz

SELECT:



SN | natur SU | umbra SB | basaltbraun SM | mineralblau SK | kupfer SH | honiggelb SS | schwarz

Construction / loading capacities:

Carcase:	table top veneered in genuine wood			
Fronts:	solid wood or coreboard veneered in genuine wood with end-grain edging			
Front glass panels:	toughened safety glass - Parsol gray			
Shelves:	wooden compartments behind wooden doors, glass compartments (Parsol grey) behind transparent front glass panels			
Metal parts / handles:	aluminium or steel, powder-coated			
Drawers:	dovetailed solid wooden drawers (oak) with concealed, easy-action fully extending pull-out			
Tables:	Solid wood frame and top. Top with hard-wearing wood surface made of lacquer-wax mixture with a natural feel.			
Loading capacities:	glass shelves 6 mm:	max. 5 kg	drawers up to 80 cm wide:	max. 10 kg
	wooden shelves:	max. 15 kg	drawers over 80 cm wide:	max. 25 kg
	chairs:	max. 110 kg	wall units:	like article description

Lighting (optional)

All lighting systems are permanently installed and wired into the furniture by VOGLAUER. Each illuminated element has its own control gear or transformer and a main power cable (approx. 2.5 m) with EURO plug.

ON/OFF either by:

- internal mini rocker switch
- wireless switch and dimmer (each furniture element is supplied with its own wireless transmitter handset - (several lights can be programmed to operate from one handset at any later date)

Power/consumption:

LED chains in aluminium channel with opal cover: 7 watts/metre (for all showcase parts)

COB LED strips with continuous phosphor layer: 5 watts/metre (for all other lighting)

Energy consumption labelling: The following applies to all VOGLAUER furniture with lighting: „This product contains a light source of energy efficiency class F“. The light sources and the associated control gear can only be replaced by qualified personnel.

Wood-based materials - indoor climate:

Despite meticulous craftsmanship, wood is a living raw material that reacts to changes in humidity and adapts to the prevailing climate. This may unavoidably result in colour and texture variations, minor cracks, slight warping or open knots. An ideal indoor climate for furniture is between approx. 18-23 °C as well as 45-55 % humidity. To reduce warping or cracks to a minimum, solid wooden furniture should be exposed to the smallest possible fluctuations in temperature or humidity.

Oiled wooden surfaces:

Our hard oil/wax combinations based on vegetable oil meet the highest environmental standards and are on a par with organic products. The oiled surface is breathable and improves the indoor climate. The surface is antistatic, i.e. dust and dirt-repellent.

Care of oiled surface: to maintain the value of oiled furniture from VOGLAUER, re-oiling is recommended every 6-8 months. Apply a thin coat of VOGLAUER care oil („care oil“ - see accessories) with a soft and non-lining cloth, rubbing evenly in the direction of the fibres. Afterwards, polish with a dry cotton cloth. The surface takes on a silky gloss and feels velvety soft.

Furniture cover materials:

- **Loden** fabric made of 100 % pure new wool
- **Vintage** fabric made of 100 % microfibre (PES)
- Sturdy soft **nappa cowhide** with scar pattern and distinctive mill grain.
- **Curl** fabric made of easy-care Q2-Hitex® yarns (74% PAN, 26 % PES)
- **Chalet** fabric made of easy-care Q2-Hitex® yarns (58% PAN, 42 % PES)
- **Select** fabric made from blended fabric (29% PES, 27% PAN, 22% CV, 13% WO, 9%

The production or processing of fabrics and leather involves many work steps which is why slight colour variations in the end product cannot be avoided. It is particularly important to bear this in mind when comparing samples and actual furniture. Puckering is a natural process and therefore no reflection of any reduction in quality. It results from using or stretching of cover materials.

Important planning information:

- To ensure proper fulfilment of the contract, all structural conditions, obstructions, dimensions and loads must be identified when ascertaining what is required.
- Identify the preliminary electrical work that is required for wiring and for connecting appliances (freely suspended lighting systems require surface-mounted or concealed cable ducting solutions). Each illuminated element has a separate mains power cable (approx. 2.5 m) with EURO plug. The mains power connection for lighting (socket, cable outlet) can be provided in the entire rear panel area of cabinet furniture (rear-panel clearance approx. 23 mm).
- Door hinges are nickel-plated and adjustable in 3 directions. However, for exact door fit, it is essential for furniture to be standing on a level and even floor; unevenness can be corrected with adjustable furniture feet.
- All dimensions stated in the product guide are theoretical approximate dimensions and may diverge from actual dimensions, especially as a result of cumulative tolerances. Handle or other insignificant component projections are not included in the overall dimensions.



Installing furniture



On account of the large doors and fully extending drawers, free-standing elements must also be fixed to the wall to prevent them from tipping forward. VOGLAUER supplies the appropriate mounting accessories for solid brickwork or masonry. For stud walls, specialist fitters must obtain suitable wall plugs screws themselves. VOGLAUER assumes no liability for installation!

All furniture is assembled and customised by VOGLAUER at the factory. Bulky furniture can be dismantled for assembly purposes or is delivered in disassembled form. VOGLAUER supplies assembly drawings for furniture that is not assembled.

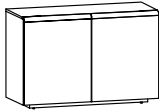
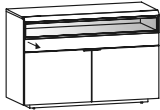
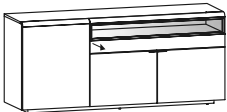
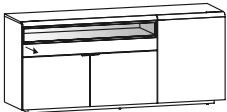
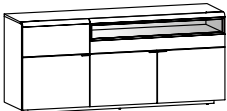
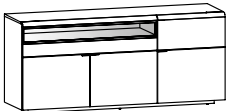

VOGLAUER furniture quality certificate:

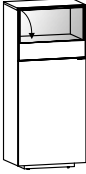
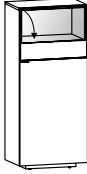
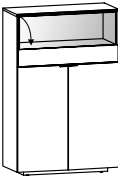
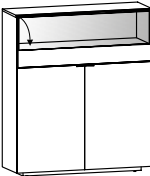
When buying VOGLAUER furniture, the VOGLAUER Furniture Quality Pass is handed over (online download: www.voglauer.com). A comprehensive documentation specifying the 5-year warranty and containing many important information such as instructions for use and care.

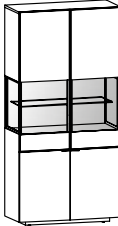
	1 adjustable shelf  WD/H in cm: 128,2 / 51,7 / 85,1	 WD/H in cm: 128,2 / 51,7 / 85,1
Description	Sideboard 128, 2 doors	Sideboard 128, 2-door, 1 drawer
Item number	CS12T	CS12-A
Surcharge for lighting with switch	--	(C-WV12)
Surcharge for lighting with radio and dimmer	--	(C-FV12)
	left 1 adjustable shelf  WD/H in cm: 192,2 / 51,7 / 85,1	right 1 adjustable shelf  WD/H in cm: 192,2 / 51,7 / 85,1
Description	Sideboard 192, 3-door, 1 drawer, LH version	Sideboard 192, 3-door, 1 drawer, RH version
Item number	CS19-L-A	CS19-R-A
Surcharge for lighting with switch		(C-WV12)
Surcharge for lighting with radio and dimmer		(C-FV12)
	 WD/H in cm: 192,2 / 51,7 / 85,1	 WD/H in cm: 192,2 / 51,7 / 85,1
Description	Sideboard 192, 3-door, 2 drawers, LH version	Sideboard 192, 3-door, 2 drawers, RH version
Item number	CSL19-L-A	CSL19-R-A
Surcharge for lighting with switch		(C-WV12)
Surcharge for lighting with radio and dimmer		(C-FV12)
	Drawer with variable interior partitioning Removable writing tablet trays for accessories power point: 2x 230V, 2x USB Lighting  WD/H in cm: 112,2 / 56 / 94	
Description	Bureau 112	
Item number	CSE11-A	
	Lighting included in the price	

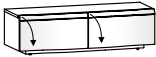
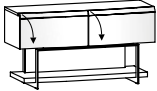
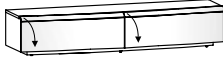
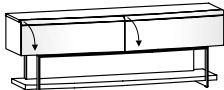
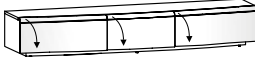
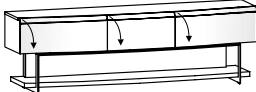
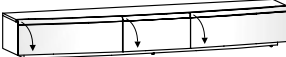
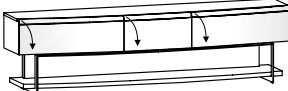

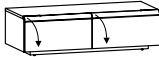
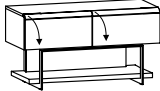

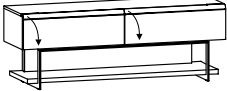
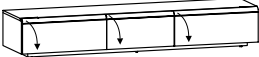
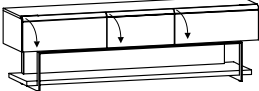
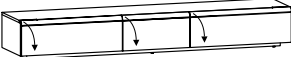
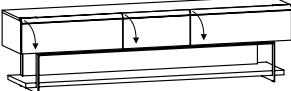
<p>Bottom door: 2 shelves</p> <p>Upper flap: 1 fixed bottom</p>	 <p>W/D/H in cm: 64,2 / 42,3 / 149,1</p>	 <p>W/D/H in cm: 64,2 / 42,3 / 149,1</p>	
	<p>Description</p> <p>Highboard 64, 1-door with glass display section, LH version</p>	<p>Description</p> <p>Highboard 64, 1-door with glass display section, RH version</p>	
<p>Item number</p> <p>CH64V-L-A</p>	<p>Item number</p> <p>CH64V-R-A</p>		
<p>Surcharge relief rear panel</p> <p>(C-R64)</p>			
<p>Surcharge for lighting with switch</p> <p>(C-WV64)</p>			
<p>Surcharge for lighting with radio and dimmer</p> <p>(C-FV64)</p>			
	 <p>W/D/H in cm: 96,2 / 42,3 / 149,1</p>	<p>Lower door: 2 shelves Upper flap: 1 fixed shelf</p>  <p>W/D/H in cm: 128,2 / 42,3 / 149,1</p>	
	<p>Description</p> <p>Highboard 96, 2-door with glass display section</p>	<p>Description</p> <p>Highboard 128, 2-door with glass display section</p>	
<p>Item number</p> <p>CH96V-A</p>	<p>Item number</p> <p>CH12V-A</p>		
<p>Surcharge relief rear panel</p> <p>(C-R96)</p>		<p>(C-R12)</p>	
<p>Surcharge for lighting with switch</p> <p>(C-WV96)</p>		<p>(C-WV12)</p>	
<p>Surcharge for lighting with radio and dimmer</p> <p>(C-FV96)</p>		<p>(C-FV12)</p>	
<p>Bottom door: 1 adjustable shelf</p> <p>Upper door: 1 adjustable shelf 2 fixed shelves 1 fixed glass shelf</p>	 <p>W/D/H in cm: 64,2 / 42,4 / 197,1</p>	 <p>W/D/H in cm: 64,2 / 42,4 / 197,1</p>	 <p>W/D/H in cm: 96,2 / 42,4 / 197,1</p>
	<p>Description</p> <p>Glass cabinet 64, 2 doors, door mounted on left</p>	<p>Description</p> <p>Glass cabinet 64, 2 doors, door mounted on right</p>	<p>Description</p> <p>Glass cabinet 96, 4 doors</p>
<p>Item number</p> <p>CV64-L-A</p>	<p>Item number</p> <p>CV64-R-A</p>	<p>Item number</p> <p>CV96-A</p>	
<p>Surcharge relief rear panel</p> <p>(C-RV64)</p>		<p>(C-RV96)</p>	
<p>Surcharge for lighting with switch</p> <p>(C-W2V64)</p>		<p>(C-W2V96)</p>	
<p>Surcharge for lighting with radio and dimmer</p> <p>(C-F2V64)</p>		<p>(C-F2V96)</p>	

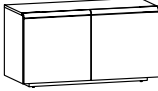
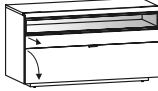
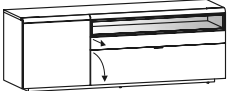
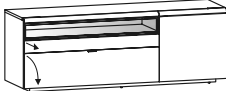
1 Middle side	 WD/H in cm: 128,2 / 47,1 / 37,1	 WD/H in cm: 128,2 / 47,1 / 69,1
Description	Lowboard curved 128/37, 2 flaps	Lowboard curved with rack 128/69, 2 flaps
Item number	CLR12	CLR12-A
Surcharge drawer 64 curved instead of flap		(C-SR64) Specify position for drawer installation
Surcharge cable management		(C-K)
Surcharge for lighting with switch	--	(C-WL12)
Surcharge for lighting with radio and dimmer	--	(C-FL12)
1 Middle side	 WD/H in cm: 192,2 / 50,4 / 37,1	 WD/H in cm: 192,2 / 50,4 / 69,1
Description	Lowboard curved 192/37, 2 flaps	Lowboard curved with rack 192/69, 2 flaps
Item number	CLR19	CLR19-A
Surcharge drawer 96 rounded instead of flap		(C-SR96) Specify position for drawer installation
Surcharge cable management		(C-K)
Surcharge for lighting with switch	--	(C-WL19)
Surcharge for lighting with radio and dimmer	--	(C-FL19)
2 middle sides	 WD/H in cm: 224,2 / 52,4 / 37,1	 WD/H in cm: 224,2 / 52,4 / 69,1
Description	Lowboard curved 224/37, 3 flaps	Lowboard curved with rack 224/69, 3 flaps
Item number	CLR22	CLR22-A
Surcharge drawer 64 curved instead of flap		(C-SR64)
Surcharge drawer 80 rounded instead of flap		(C-SR80) Specify position for drawer installation
Surcharge cable management		(C-K)
Surcharge for lighting with switch	--	(C-WL22)
Surcharge for lighting with radio and dimmer	--	(C-FL22)
2 middle sides	 WD/H in cm: 256,2 / 54,9 / 37,1	 WD/H in cm: 256,2 / 54,9 / 69,1
Description	Lowboard curved 256/37, 3 flaps	Lowboard curved with rack 256/69, 3 flaps
Item number	CLR25	CLR25-A
Surcharge drawer 64 curved instead of flap		(C-SR64)
Surcharge drawer 96 rounded instead of flap		(C-SR96) Specify position for drawer installation
Surcharge cable management		(C-K)
Surcharge for lighting with switch	--	(C-WL25)
Surcharge for lighting with radio and dimmer	--	(C-FL25)

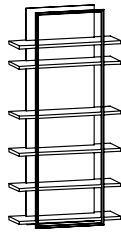
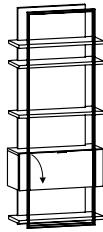
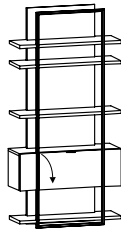
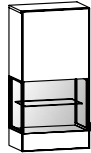
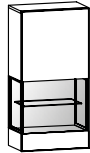
1 Middle side	 WD/H in cm: 128,2 / 55,1 / 37,1	 WD/H in cm: 128,2 / 55,1 / 69,1
Description	Lowboard 128/37, 2 flaps	Lowboard with rack 128/69, 2 flaps
Item number	CL12	CLF12-A
Surcharge drawer 64 instead of flap		(C-S64) Specify position for drawer installation
Surcharge cable management		(C-K)
Surcharge for lighting with switch	--	(C-WL12)
Surcharge for lighting with radio and dimmer	--	(C-FL12)
1 Middle side	 WD/H in cm: 192,2 / 55,1 / 37,1	 WD/H in cm: 192,2 / 55,1 / 69,1
Description	Lowboard 192/37, 2 flaps	Lowboard with rack 192/69, 2 flaps
Item number	CL19	CLF19-A
Surcharge drawer 96 instead of flap		(C-S96) Specify position for drawer installation
Surcharge cable management		(C-K)
Surcharge for lighting with switch	--	(C-WL19)
Surcharge for lighting with radio and dimmer	--	(C-FL19)
2 middle sides	 WD/H in cm: 224,2 / 55,1 / 37,1	 WD/H in cm: 224,2 / 55,1 / 69,1
Description	Lowboard 224/37, 3 flaps	Lowboard with rack 224/69, 3 flaps
Item number	CL22	CLF22-A
Surcharge drawer 64 instead of flap		(C-S64)
Surcharge drawer 80 instead of flap		(C-S80) Specify position for drawer installation
Surcharge cable management		(C-K)
Surcharge for lighting with switch	--	(C-WL22)
Surcharge for lighting with radio and dimmer	--	(C-FL22)
2 middle sides	 WD/H in cm: 256,2 / 55,1 / 37,1	 WD/H in cm: 256,2 / 55,1 / 69,1
Description	Lowboard 256/37, 3 flaps	Lowboard with rack 256/69, 3 flaps
Item number	CL25	CLF25-A
Surcharge drawer 64 instead of flap		(C-S64)
Surcharge drawer 96 instead of flap		(C-S96) Specify position for drawer installation
Surcharge cable management		(C-K)
Surcharge for lighting with switch	--	(C-WL25)
Surcharge for lighting with radio and dimmer	--	(C-FL25)

	1 adjustable shelf  W/D/H in cm: 128,2 / 55,1 / 69,1	  W/D/H in cm: 128,2 / 55,1 / 69,1
Description	Lowboard 128/69, 2 doors	Lowboard 128/69, 1 flap, 1 drawer
Item number	CLH12T	CLH12-A
Surcharge drawer 128 instead of flap	--	(C-S12)
Surcharge cable management	(C-K)	(C-K)
Surcharge for lighting with switch	--	(C-WV12)
Surcharge for lighting with radio and dimmer	--	(C-FV12)
	left 1 adjustable shelf  W/D/H in cm: 192,2 / 55,1 / 69,1	right 1 adjustable shelf  W/D/H in cm: 192,2 / 55,1 / 69,1
Description	Lowboard 192/69, 1 door, 1 flap, 1 drawer, LH version	Lowboard 192/69, 1 door, 1 flap, 1 drawer, RH version
Item number	CLH19-L-A	CLH19-R-A
Surcharge drawer 128 instead of flap		(C-S12)
Surcharge cable management		(C-K)
Surcharge for lighting with switch		(C-WV12)
Surcharge for lighting with radio and dimmer		(C-FV12)

	 W/D/H in cm: 80 / 33 / 197,1	 W/D/H in cm: 96 / 33 / 197,1
Description	Rack 80/197	Rack 96/197
Item number	CR819-A	CR919-A
Surcharge for lighting with switch		(C-WR19)
Surcharge for lighting with radio and dimmer		(C-FR19)
	 W/D/H in cm: 80,2 / 33,1 / 197,1	Front left and right 1 smal door each  W/D/H in cm: 96,2 / 33,1 / 197,1
Description	Rack 80/197, with flap element	Rack 96/197, with flap element
Item number	CR819K-A	CR919K-A
Surcharge for lighting with switch		(C-WR19)
Surcharge for lighting with radio and dimmer		(C-FR19)
Total loading capacity 70 kg maximum 1 adjustable shelf 2 fixed shelves 1 fixed glass shelf	 W/D/H in cm: 64,2 / 37,3 / 128	 W/D/H in cm: 64,2 / 37,3 / 128
Description	Wall unit 64/128 with glass display section, door mounted on left	Wall unit 64/128 with glass display section, door mounted on right
Item number	CHE64-L-A	CHE64-R-A
Surcharge relief rear panel		(C-RV64)
Surcharge for lighting with switch		(C-W2V64)
Surcharge for lighting with radio and dimmer		(C-F2V64)

Total loading capacity 10 kg maximum Wall shelves with plug-in fitting				
	W/D/H in cm: 128 / 24 / 3,9	W/D/H in cm: 160 / 24 / 3,9	W/D/H in cm: 176 / 24 / 3,9	W/D/H in cm: 192 / 24 / 3,9
Description	Wall shelf 128 cm	Wall shelf 160 cm	Wall shelf 176 cm	Wall shelf 192 cm
Item number	CWS12	CWS16	CWS17	CWS19

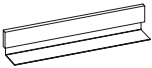
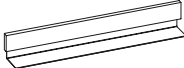
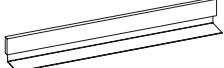
Total loading capacity 10 kg maximum			
	W/D/H in cm: 128 / 20 / 24	W/D/H in cm: 160 / 20 / 24	W/D/H in cm: 192 / 20 / 24
Description	Wall shelf 128 with metal shelf	Wall shelf 160 with metal shelf	Wall shelf 192 with metal shelf
Item number	CWB12-A	CWB16-A	CWB19-A
Surcharge for lighting with switch	(C-W12)	(C-W16)	(C-W19)
Surcharge for lighting with radio and dimmer	(C-F12)	(C-F16)	(C-F19)

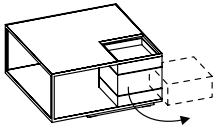
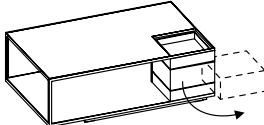
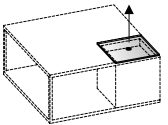
			Clear glass 1,6 cm with grip hole
			W/D/H in cm: 80 / 80 / 40
Description	Coffee table 80/80 with rotating drawer	Coffee table 75/120 with rotating drawer	Glass plate 31/31 cm for coffee table
Item number	CC88-A	CC71-A	CCGA

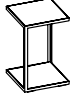









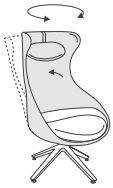





	W/D/H in cm: 32 / 32 / 50	
	Description	Side table 32/32
	Item number	CB33-A

<p>Frame and top Solid wood</p> <p>Plate thickness 2,6 cm (down skewed)</p> <p>Table height 76.5 cm</p>			<p>Pull-out rails and folding inlay solid wood</p>		
			for alle Tische	for tables from 160	for table 200



Description	Dining table with slantet food							Surcharge flap insert 50	Surcharge for flap insert 80	Surcharge flap insert 100
W/L in cm:	90 / 140	90 / 160	90 / 180	90 / 200	100 / 160	100 / 180	100 / 200	+50 cm	+80 cm	+100 cm
Item number	CS914	CS916	CS918	CS920	CS116	CS118	CS120	C-S5H	C-S8H	C-S1H

<p>Seat height 50 cm Total depth ~57 cm Total height ~79 cm</p> <p>Seat upholstery: Foam 3,5 cm Volume weight 50 Upset hardness 75</p>				

Description	Bench upholstered 147 cm		Bench upholstered 167 cm		Bench upholstered 187 cm		Bench upholstered 207 cm	
suitable table size	140 cm		160 cm		180 cm		200 cm	
Item number	CB14		CB16		CB18		CB20	
Cover fabric	Fabric	Leather	Fabric	Leather	Fabric	Leather	Fabric	Leather

Seat height ~45 cm with felt glides	Neck cushion with same cover as moulded back Moulded back and seat available with various cover materials!				Moulded back and seat available with various cover materials!						
	 <div style="border: 1px solid black; padding: 5px; width: fit-content;"> Please state when ordering <input type="checkbox"/> Cover, moulded back <input type="checkbox"/> Cover, seat </div> <p style="text-align: center;">W/D/H in cm: 78 / 83 / 123</p>				 <div style="border: 1px solid black; padding: 5px; width: fit-content;"> Please state when ordering <input type="checkbox"/> Cover, moulded back <input type="checkbox"/> Cover, seat </div> <p style="text-align: center;">W/D/H in cm: 52 / 51 / 45</p>						
Description	Wing chair 15 upholstered				Stool 15 upholstered						
Item number	OS15				HO15						
Cover fabric	Fabric	Leather	Cover fabric Fabric Seat Leather	Moulded back Leather Seat Fabric	Fabric	Leather	Moulded back Fabric Seat Leather	Moulded back Leather Seat Fabric			
Seat height 49 cm All chairs with plastic glides (felt gliders are also included)	Moulded back rest, other cover possible			Rotatable seat with rocker function		Rotatable seat with rocker function		Back rest, other cover possible			
	 <div style="border: 1px solid black; padding: 5px; width: fit-content;"> Please state when ordering <input type="checkbox"/> Cover, moulded back <input type="checkbox"/> Cover, seat </div> <p style="text-align: center;">W/D/H in cm: 50 / 61 / 88</p>			 <div style="border: 1px solid black; padding: 5px; width: fit-content;"> Please state when ordering <input type="checkbox"/> Cover, moulded back <input type="checkbox"/> Cover, seat </div> <p style="text-align: center;">W/D/H in cm: 50 / 61 / 85</p>		 <div style="border: 1px solid black; padding: 5px; width: fit-content;"> Please state when ordering <input type="checkbox"/> Cover, moulded back <input type="checkbox"/> Cover, seat </div> <p style="text-align: center;">W/D/H in cm: 50 / 61 / 85</p>		 <div style="border: 1px solid black; padding: 5px; width: fit-content;"> Please state when ordering <input type="checkbox"/> Cover, back rest <input type="checkbox"/> Cover, seat </div> <p style="text-align: center;">W/D/H in cm: 58 / 62 / 82</p>			
Description	Chair 64, seat and back upholstered			Chair 65 upholstered, metal frame		Chair 66 upholstered, wooden frame					
Item number	SEGP64			SEGP65		SEGP66					
Cover fabric	Fabric	Leather	Leather/fabric combined	Fabric	Leather	Back rest Fabric Seat Leather	Back rest Seat Fabric	Fabric	Leather	Back rest Fabric Seat Leather	Back rest Seat Fabric
Seat height 49 cm All chairs with plastic glides (felt gliders are also included)	Upholstered chair 26		Upholstered chair 36, rocking backrest		Chair 76, upholstered with armrests, metal frame		Chair 78, upholstered with armrests, wooden frame		Chair 77 with armrests, seat and back upholstered		
	 <p style="text-align: center;">W/D/H in cm: 57 / 57 / 82</p>		 <p style="text-align: center;">W/D/H in cm: 57 / 57 / 82</p>		 <p style="text-align: center;">W/D/H in cm: 60 / 58 / 82</p>		 <p style="text-align: center;">W/D/H in cm: 60 / 59 / 82</p>		 <p style="text-align: center;">W/D/H in cm: 58 / 62 / 82</p>		
Description	Upholstered chair 26		Upholstered chair 36, rocking backrest		Chair 76, upholstered with armrests, metal frame		Chair 78, upholstered with armrests, wooden frame		Chair 77 with armrests, seat and back upholstered		
Item number	SEGP26		SEGP36		SAGP76		SAGP78		SAGP77		
Cover fabric	Fabric	Leather	Fabric	Leather	Fabric	Leather	Fabric	Leather	Fabric	Leather	Leather/fabric combined
Seat height 49 cm All chairs with plastic glides (felt gliders are also included)	Stackable chair		Stackable chair		Stackable chair		Stackable chair		Stackable chair		Stackable chair
	 <p style="text-align: center;">W/D/H in cm: 54 / 61 / 86</p>		 <p style="text-align: center;">W/D/H in cm: 54 / 57 / 82</p>		 <p style="text-align: center;">W/D/H in cm: 53 / 57 / 82</p>		 <p style="text-align: center;">W/D/H in cm: 57 / 58 / 83</p>		 <p style="text-align: center;">W/D/H in cm: 51 / 49 / 93</p>		 <p style="text-align: center;">W/D/H in cm: 52 / 51,5 / 103</p>
Description	Chair 55, seat upholstered, wooden back		Chair 35, seat upholstered, wooden back		Upholstered chair 35		Upholstered chair 37 with armrests		Barstool 35, seat height approx. 66 cm		Barstool 35, seat height approx. 76 cm
Item number	SEHP55		SEHP35		SEGP35		SAGP37		BAN35		BAH35
Cover fabric	Fabric	Leather	Fabric	Leather	Fabric	Leather	Fabric	Leather	Fabric	Leather	Leather

		(coreboard, veneered, edged all round) Max. length 252 cm max. width 110 cm Material thickness: 14, 20 or 23 mm  (At least 0.5 m² will be charged)	
Description		Filler panel, both sides veneered	
Item number		BLBS	
		(per m²)	

	WOOD CARE		FABRIC CARE	
	250 ml VOGLAUER maintenance oil and polishing cloth  Genuine VOGLAUER care oil cleans or refreshes the surface, leaving a breathable protective film.	100 ml of VOGLAUER cleaning milk and repair oil, Scotch-Brite and polishing cloths  For repairing minor surface damage and removing soiling	200 ml of demineralised cleaning water and synthetic fibre cleaner, cleaning glove, brush and cloth.  For collection CURL CHALET SELECT VINTAGE	The genuine VOGLAUER care and cleaning set contains everything that is needed for regular cleaning and maintenance of synthetic fibre covers. Used regularly, these products will keep upholstery covers looking beautiful and well-maintained for years to come.
Description	Care set for oiled surfaces	Repairing set for oiled surfaces	Care and cleaning set for synthetic fibres	
Item number	PSET	RSET	VISET	

	LEATHER CARE			
	200 ml of gentle cleaner and care lotion with light protection, sponge and cloths.  The genuine VOGLAUER leather care set for cleaning leather thoroughly and gently as well as impregnating it. Recommendation: 2 - 4 applications a year.	For removing heavy, non-greasy soiling and dust on the leather. 	Highly effective impregnation and light protection. The leather is re-moisturised, keeping it supple. Delays colour fading. 	For refreshing the leather colour of slightly faded or worn leather. Recommendation: Afterwards, impregnate with care lotion. Specify LEATHER COLOUR. 
Description	Leather care set	Leather cleaner 200 ml	Leather care lotion 200 ml	Leather colour lotion 200 ml
Item number	LESET	LEREI	LEPFL	LEFAL

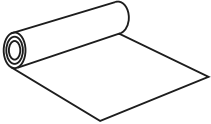
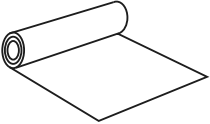
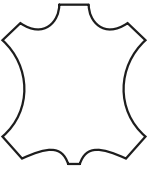
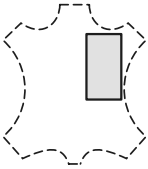
	FURNITURE COVER MATERIALS			
	Fabric collection: CURL, CHALET, VINTAGE, SELECT  Fabric width 140 cm	Fabric collection: LODEN  Fabric width 150 cm	Leather collection: MONTAN 	Leather collection: MONTAN  80/80 cm maximum (At least 0.5 m² will be charged)
Description	Fabric	Fabric	Cowhide leather complete approx. 4 - 5 m²	Leather
Item number	MBST	MBST	LEHAU	LEZU
	(per metre)	(per metre)	(each)	(per m²)

<p>Suggestion 108 W/D/H in cm: 256 / 55,1 / 197,1</p> 	Metal	anthracite
	Article number as illustrated	CV108-L-A
	Article number mirror-inverted	CV108-R-A
	Surcharge relief rear panel (C-RV64)	
	Surcharge for lighting with switch (C-W2V64, C-W19)	
	Surcharge for lighting with radio and dimmer (C-F2V64, C-F19)	
	Surcharge drawer 80 instead of flap (C-S80)*	
	Surcharge drawer 64 instead of flap (C-S64)	
	Surcharge cable management (C-K)	
	Suggestion (illustrated) consisting of:	1x CL22 Lowboard 224/37, 3 flaps 1x CHE64-L Wall unit 64/128 with glass display section, door mounted on left 1x CWB19 Wall shelf 192 with metal shelf

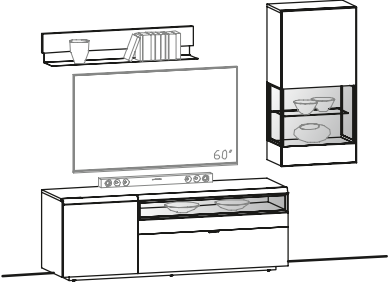
<p>Suggestion 111 W/D/H in cm: 256 / 55,1 / 212</p> 	Metal	anthracite
	Article number as illustrated	CV111-L-A
	Article number mirror-inverted	CV111-R-A
	Surcharge relief rear panel (C-RV64)	
	Surcharge for lighting with switch (C-W2V64, C-WV12, C-W12)	
	Surcharge for lighting with radio and dimmer (C-F2V64, C-FV12, C-F12)	
	Surcharge drawer 128 instead of flap (C-S12)	
	Surcharge cable management (C-K)	
	Suggestion (illustrated) consisting of:	1x CLH19-L Lowboard 192/69, 1 door, 1 flap, 1 drawer, LH version 1x CHE64-R Wall unit 64/128 with glass display section, door mounted on right 1x CWB12 Wall shelf 128 with metal shelf

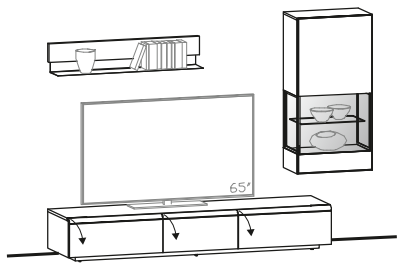
<p>Suggestion 114 W/D/H in cm: 265 / 55,1 / 189,1</p> 	Metal	anthracite
	Article number as illustrated	CV114-L-A
	Article number mirror-inverted	CV114-R-A
	Surcharge relief rear panel (C-RV64)	
	Surcharge for lighting with switch (C-W2V64, C-W12)	
	Surcharge for lighting with radio and dimmer (C-F2V64, C-F12)	
	Surcharge drawer 80 instead of flap (C-S80)*	
	Surcharge drawer 64 instead of flap (C-S64)	
	Surcharge cable management (C-K)	
	Suggestion (illustrated) consisting of:	1x CL22 Lowboard 224/37, 3 flaps 1x CHE64-R Wall unit 64/128 with glass display section, door mounted on right 1x CWB12 Wall shelf 128 with metal shelf

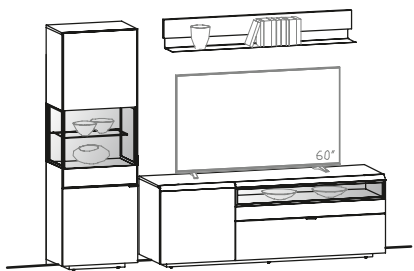
<p>Suggestion 121 W/D/H in cm: 272 / 55,1 / 197</p> 	Metal	anthracite
	Article number as illustrated	CV121-L-A
	Article number mirror-inverted	CV121-R-A
	Surcharge relief rear panel (C-RV64)	
	Surcharge for lighting with switch (C-W2V64, C-WV12, C-W16)	
	Surcharge for lighting with radio and dimmer (C-F2V64, C-FV12, C-F16)	
	Surcharge drawer 128 instead of flap (C-S12)	
	Surcharge cable management (C-K)	
	Suggestion (illustrated) consisting of:	1x CLH19-L Lowboard 192/69, 1 door, 1 flap, 1 drawer, LH version 1x CV64-L Glass cabinet 64, 2 doors, door mounted on left 1x CWB16 Wall shelf 160 with metal shelf

<p>Suggestion 166 W/D/H in cm: 297 / 54,9 / 212</p>	Metal	anthracite
	Article number as illustrated	CV166-L-A
	Article number mirror-inverted	CV166-R-A
	Surcharge relief rear panel (C-RV64)	
	Surcharge for lighting with switch (C-WL25, C-W2V64, C-W16)	
	Surcharge for lighting with radio and dimmer (C-FL25, C-F2V64, C-F16)	
	Surcharge drawer 64 curved instead of flap (C-SR64)	
	Surcharge drawer 96 rounded instead of flap (C-SR96)*	
	Surcharge cable management (C-K)	
	Suggestion (illustrated) consisting of:	1x CLRF25 Lowboard curved with rack 256/69, 3 flaps 1x CHE64-L Wall unit 64/128 with glass display section, door mounted on left 1x CWB16 Wall shelf 160 with metal shelf

<p>Suggestion 168 W/D/H in cm: 297 / 55,1 / 212</p>	Metal	anthracite
	Article number as illustrated	CV168-L-A
	Article number mirror-inverted	CV168-R-A
	Surcharge relief rear panel (C-RV64)	
	Surcharge for lighting with switch (C-WL25, C-W2V64, C-W19)	
	Surcharge for lighting with radio and dimmer (C-FL25, C-F2V64, C-F19)	
	Surcharge drawer 64 instead of flap (C-S64)	
	Surcharge drawer 96 instead of flap (C-S96)*	
	Surcharge cable management (C-K)	
	Suggestion (illustrated) consisting of:	1x CLF25 Lowboard with rack 256/69, 3 flaps 1x CHE64-R Wall unit 64/128 with glass display section, door mounted on right 1x CWB19 Wall shelf 192 with metal shelf

<p>Suggestion 173 W/D/H in cm: 303 / 52,4 / 189,1</p>	Metal	anthracite
	Article number as illustrated	CV173-L-A
	Article number mirror-inverted	CV173-R-A
	Surcharge relief rear panel (C-RV64)	
	Surcharge for lighting with switch (C-W2V64, C-W12)	
	Surcharge for lighting with radio and dimmer (C-F2V64, C-F12)	
	Surcharge drawer 80 rounded instead of flap (C-SR80)*	
	Surcharge drawer 64 curved instead of flap (C-SR64)	
	Surcharge cable management (C-K)	
	Suggestion (illustrated) consisting of:	1x CLR22 Lowboard curved 224/37, 3 flaps 1x CHE64-R Wall unit 64/128 with glass display section, door mounted on right 1x CWB12 Wall shelf 128 with metal shelf

<p>Suggestion 185 W/D/H in cm: 303 / 55,1 / 197,1</p>	Metal	anthracite
	Article number as illustrated	CV185-L-A
	Article number mirror-inverted	CV185-R-A
	Surcharge for lighting with switch (C-WV12, C-WR19)	
	Surcharge for lighting with radio and dimmer (C-FV12, C-FR19)	
	Surcharge drawer 128 instead of flap (C-S12)	
	Surcharge cable management (C-K)	
	Suggestion (illustrated) consisting of:	1x CLH19-R Lowboard 192/69, 1 door, 1 flap, 1 drawer, RH version 1x CR919 Rack 96/197

*Please specify where to mount additional articles. (Drawing)

<p>Suggestion 311 W/D/H in cm: 335 / 54,9 / 197</p>	Metal	anthracite
	Article number as illustrated	CV311-L-A
	Article number mirror-inverted	CV311-R-A
	Surcharge relief rear panel (C-RV64)	
	Surcharge for lighting with switch (C-WL25, C-W2V64, C-W19)	
	Surcharge for lighting with radio and dimmer (C-FL25, C-F2V64, C-F19)	
	Surcharge drawer 64 curved instead of flap (C-SR64)	
	Surcharge drawer 96 rounded instead of flap (C-SR96)*	
	Surcharge cable management (C-K)	
	Suggestion (illustrated) consisting of:	

<p>Suggestion 407 W/D/H in cm: 377 / 55,1 / 212</p>	Metal	anthracite
	Article number as illustrated	CV407-L-A
	Article number mirror-inverted	CV407-R-A
	Surcharge relief rear panel (C-R64, C-RV64)	
	Surcharge for lighting with switch (C-WL25, C-W2V64, C-WV64, C-W16)	
	Surcharge for lighting with radio and dimmer (C-FL25, C-F2V64, C-FV64, C-F16)	
	Surcharge drawer 64 instead of flap (C-S64)	
	Surcharge drawer 96 instead of flap (C-S96)*	
	Surcharge cable management (C-K)	
	Suggestion (illustrated) consisting of:	



Design. Nature. Handcraft.



A commitment to nature and quality for over 90 years.

Innovative with consideration of the green and social environment



Ecolabels für 	Energy/Recycling 	Social responsibility 
<ul style="list-style-type: none"> • Raw material and energy consumption • certified ingredients • Emissions • Disposal / recycling • Packaging • Distribution and transport • Quality, safety, durability • Only environmentally and quality certified suppliers 	<ul style="list-style-type: none"> • Thermal utilisation of 95 % of the wood waste • Recycling of all water-based lacquers and woodstripers • Energy comes from renewable energy sources • Conscious waiver of air conditioning systems due to special night-ventilation system. 	<ul style="list-style-type: none"> • Voglauer Academy – Training of the employees • Free Shuttle-Service for employees • Company cafeteria • Support of public safety organisations



Wood from sustaining sources

Furniture – pure and genuine



Oak

Wooden furniture for a pleasant atmosphere

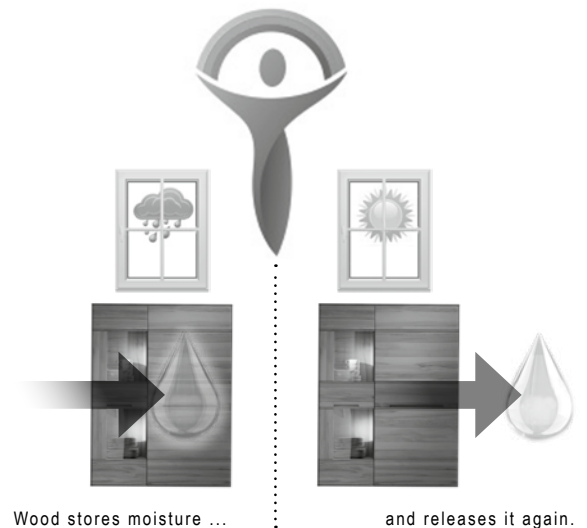



ALL VOGLAUER MODELS



LIVING / DINNING



Valpin



Vmontanara



Vrock living



Vtektura living



SLEEPING



Valpin sleeping



Vmontanara sleeping



Vvaganto



HALL



Valpin



Vmontanara



Vrock coming



Vtektura coming



BATH



Valpin bad

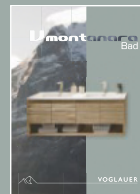

Vmontanara bad



Vquell



Vlineos

CERTIFICATIONS & AWARDS



VOGLAUER



www.voglauer.com