

U alpin

Dielen



VOGLAUER

Valpin Aus Freude am Original

For the satisfaction of being original

Le plaisir du retour aux sources

Wir achten bewusst darauf, die im Holz **charakteristischen Lebenslinien**, aber auch die **Inchrift und Spuren** zu erhalten. Es sind Möbel, die **Individualität und Wärme** vermitteln und zugleich in außergewöhnlicher Weise den Spagat zwischen Tradition und Moderne schaffen.

We make sure that the **wood's characteristic life lines** as well as **inscriptions and marks** are retained. These are **unique and warm pieces of furniture** that combine tradition and modernity.

Nous nous efforçons de préserver les **lignes de vie caractéristiques** du bois ainsi que les différentes **marques**. Ce sont des **meubles singuliers et chaleureux** qui réussissent à concilier tradition et modernité.



Dielenvorschlag AD28 | Eiche Altholz |
Parsolspiegel | Loden MG grauweiß



Valpin Video

100% NATUR | nature | nature

100% DESIGN | design | design

100% DURCHDACHT | sophisticated | bien pensé

100% VERANTWORTUNG | responsibility | responsabilité



Design. Natur. Handwerk.

Design. Nature. Craftsmanship.
Le design. La nature. L'artisanat.



Naturholzmöbel aus nachhaltigem Anbau

Natural wood furniture made from sustainable timber
Meubles en bois naturel issu de plantations durables



Bekenntnis zu Natur und Qualität seit über 90 Jahren

Commitment to nature and quality for more than 90 years
L'engagement de produire des meubles naturels de qualité depuis plus de 90 ans



Naturholzmöbel sorgen für ein gesundes Raumklima

Natural wood furniture ensure a healthy room climate
Les meubles en bois naturel assurent un climat ambiant particulièrement sain



Innovativ mit Rücksicht auf die grüne und soziale Umwelt

Innovative in caring for the social and natural environment
Innové en prenant soin de l'environnement social et naturel



Zertifiziert und ausgezeichnet

Certified and award-winning
Certifié et récompensé

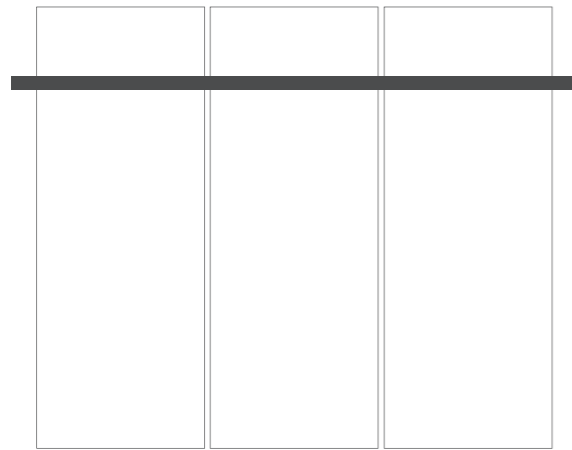

Variabel in die Höhe einhängbar
 Variable height suspension
 Suspension à hauteur variable

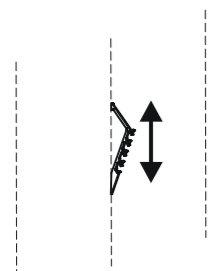

Haken Winkel
 Hook
 Crochet

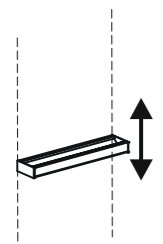

Utensilienablage
 Utility tray
 Tablette

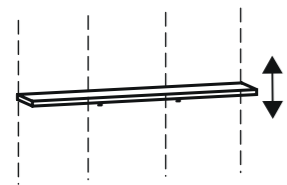

Holzboard
 Wooden board
 Étagère



Dielenvorschlag 12
 Eiche Altholz | Colorglas anthrazit

Ankommen – Ablegen – Verstauen – Wohlfühlen

Arrive – Deposit – Store – Feel good

Arriver – Déposer – Ranger – Se sentir bien

Stummer Diener mit Kubus inkl. Tür
 Valet stand with wooden cube including door
 Valet avec petit placard en bois.





Multifunktions Highboard mit Apothekerauszug
 Multifunctional highboard with pharmacist drawer
 Commode haute multifonctions avec tiroirs



Das patentierte Einhängesystem mit oder ohne Licht sorgt für maximale Flexibilität

The patented suspension system with or without light ensures maximum flexibility

Le système d'accrochage breveté, avec ou sans éclairage, permet un maximum de flexibilité.



Utensilienablage
 Utility tray
 Tablette de rangement



Dielenvorschlag AD42
Eiche Altholz | Glas anthrazit | Loden MG grauweiß

Eiche Altholz - ein Holz mit Geschichte

Old oak - wood with a history

Chêne ancien – un bois chargé d'histoire



Dieses Holz erinnert an alte Bauernhäuser und „Stadl'n". Die entstandenen Gebrauchsspuren erhielt dieses Holz durch die Einflüsse von Sonne, Wind und Wetter.

This wood is reminiscent of old farmhouses and barns. This results in a wood marked by sun, wind and weather.

Ce bois évoque les anciennes fermes et greniers. Les traces d'usure sur ce bois sont dues à l'action du soleil, du vent et des intempéries.



Dielenvorschlag AD49 | 1 Eiche Altholz |
Glas anthrazit + Parsolspiegel | Loden MG grauweiß

Inspirierend, echt & unverfälscht

Inspirational, real & genuine

Source d'inspiration, authentique & vrai



Holz & Glas – ein spannender
Materialmix

Wood & glass – An exciting
mix of materials

Bois et verre – une alliance
de matériaux fascinante



Dielenvorschlag AD35 | Eiche Altholz |
Parsolspiegel | Leder LN anthrazit



Die puristischen Möbel von Valpin in Eiche Altholz sorgen für außergewöhnliches Wohnflair.

Purist furniture by Valpin made of reclaimed oak provides exceptional living flair.

Les meubles aux lignes épurées Valpin en chêne ancien assurent un charme intérieur exceptionnel.

Mensch und Holz – eine Wohngemeinschaft mit der Natur

Human beings and wood – living in communion with nature

L'homme et le bois – vivre en communion avec la nature



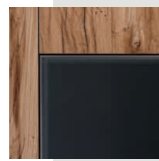

Colorglas - anthrazit

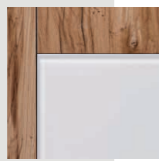

Colorglas - optiwhite



Eiche Altholz



MG | grauweiß



MB | basaltgrau



MT | tundra Braun



CN | natur



CM | melange



CW | warm grey



CT | timber

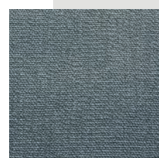

CS | steele

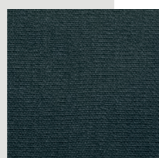

CB | black



CO | olive

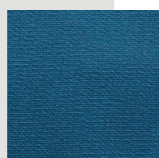

CD | dark blue

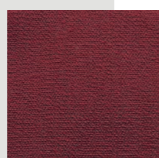

CR | royal red

Glasakzent

Glass accent
Accent verre

Sorgsam ausgesuchte Hölzer

Wood: reclaimed oak
Bois: chêne ancien

Bezugstoff | Fabric | Tissu d'ameublement

* eingeschränkt verfügbar, siehe Typenliste (Webseite) | limited availability, see type list (website)
| disponibilité limitée, voir liste de modèles (site web)

Loden | Loden | Loden

Loden besteht aus 100% reiner Merino-Schurwolle und ist daher ein hochwertiges Naturprodukt. Der Rohstoff Wolle ist langlebig, luftdurchlässig, hautfreundlich, elastisch, isolierend und durch seinen Fettgehalt schmutzabweisend.

Loden consists of 100% pure Merino Wool, and is therefore a high-quality natural product. Raw wool is durable, breathable, skin-friendly, elastic, insulating and dirt resistant due to its fat content.

Le loden est composé à 100% de pure laine vierge mérinos et est de ce fait un produit naturel de grande valeur. La matière première laine présente une durée de vie élevée, est perméable à l'air, agréable sur la peau, élastique, isolante et repousse la saleté grâce à sa teneur en graisse.

Curl | Curl | Curl

Textil in Naturhaptik mit höchster schmutzabweisender Eigenschaft (Patentiert Q2 Faser, 74/26 PAN/PES).

Textile in natural haptics with highest dirt-repellent property (patented Q2 fiber, 74/26 PAN/PES).

Textile au touché naturel avec propriétés hautement anti-poussière (breveté Q2 fibre, 74/26 PAN/PES).

Voglauer Qualitätssiegel

Voglauer seal of quality
La qualité Voglauer

Achten Sie auf das Voglauer Label und den Brennstempel – das Qualitätssiegel für originale Voglauer Möbel aus dem Salzburger Land. Hier kaufen Sie höchste Qualität und Natürlichkeit!

The Voglauer label and the branding iron are the hallmark of quality for original Voglauer furniture from Salzburger Land. Here you will purchase premium quality and naturalness!

Les labels Voglauer sont la marque de qualité de meubles originaux provenant du Salzburger Land. Chez Voglauer, vous ne trouverez que des meubles naturels et de qualité supérieure!

MATERIALIEN

MATERIALS | MATÉRIAUX



LR | reinweiß



LY | ziegelrot



LZ | army green



LU | caffè



LK | kiesel



LM | stone

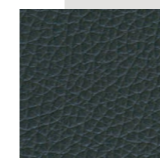

LN | anthrazit

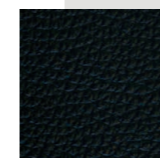

LS | schwarz

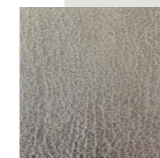

VQ | quarz

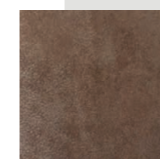

VT | terra

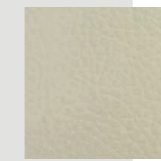

LW | sahne

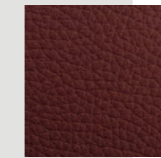

LX | burgundy



LV | cognac

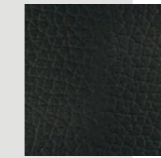

LT | testa di moro



LO | coco

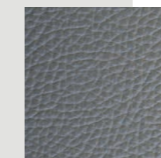

LP | cenere

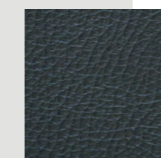

LL | oceano

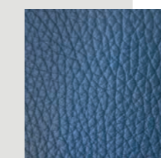

LA | azurblau

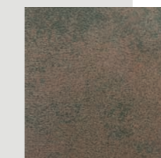

VB | bronze

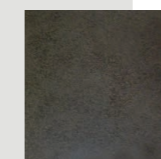

VM | moor

Leder

Leather | Cuir

Kräftiges, weiches Rindleder mit markanter Oberflächenstruktur (Millkorn) und hochwertigen Farbpigmenten.

Strong, soft cowhide leather with distinctive surface structure and high-quality colour pigments.

Cuir de vachette résistant, souple, à la surface remarquable et aux pigments colorés haut de gamme.

Vintage

Vintage | Vintage

Textilleider in used look aus 100% Mikrofaser (PES).

Faux leather in used look made from 100% microfiber (PES).

Cuir synthétique effet usé, 100% microfibrés (PES).



CP | perl

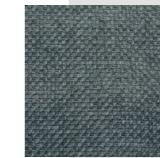

CU | umbragrau



SB | basaltbraun

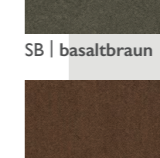

SK | kupfer

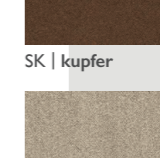

SN | natur



SU | umbra

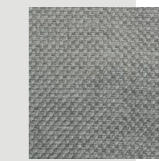

CK | kiesel

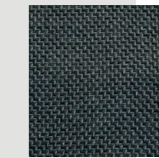

CV | vidalschwarz



SH | honiggelb

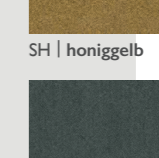

SM | mineralblau

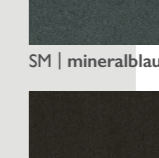

SS | schwarz

Chalet

Chalet | Chalet

Textil in Naturhaptik mit höchster schmutzabweisender Eigenschaft (Patentiert Q2 Faser, 74/26 PAN/PES).

Textile in natural haptics with highest dirt-repellent property (patented Q2 fiber, 74/26 PAN/PES).

Textile au touché naturel avec propriétés hautement anti-poussière (breveté Q2 fibre, 74/26 PAN/PES).

Select

Select | Select

Textil mit natürlicher Haptik aus Mischgewebe. (29% PES, 27% PAN, 22% CV, 13% WO, 9% CO).

Textile with a natural feel made from blended fabric. (29% PES, 27% PAN, 22% CV, 13% WO, 9% CO).

Textile au touché naturel en tissu mélangé. (29% PES, 27% PAN, 22% CV, 13% WO, 9% CO).



Farbabbildungen dienen nicht als Farbmuster!
The images do not serve as samples!
Les représentations ne servent pas d'échantillon!



Im Kreislauf mit der Natur

Als verantwortungsvoller Produzent von Naturholzmöbeln steht die Marke Voglauer seit jeher für einen nachhaltigen Umgang mit den Ressourcen der Natur. Daher werden im Fertigungsprozess ausschließlich Hölzer aus nachhaltiger Forstwirtschaft verwendet, womit Voglauer voll im Kreislauf mit der Natur produziert.

Jeder verwendete Baum, den man sich als Möbel ins Haus holt, wächst mit Garantie wieder nach.

Die Möbel von Valpin bestechen nicht nur durch formvollendetes Design, sondern auch durch höchste Qualität und Natürlichkeit.

Damit die natürlichen Oberflächen dieser Möbel besonders gut zum Ausdruck kommen, werden sie mit dem einzigartigen Voglauer Oberflächensortiment behandelt. Aus nachwachsenden Rohstoffen hergestellt, schafft diese Hartöl-Wachskombination auf Basis pflanzlicher Öle die perfekten Voraussetzungen für gesundes Wohnen.

In harmony with the natural cycle

As a responsible manufacturer of natural wood furniture, Voglauer has always stood for sustainable use of nature's resources. Therefore, only wood from sustainable forestry is used in the production process, which means that Voglauer produces in total harmony with natural cycles.

Every tree used to make our furniture is guaranteed to grow back.

Valpin furniture not only impresses with its naturalness, but also with its refined design and its highest quality.

To ensure that the natural surfaces of this furniture are particularly well expressed, they are treated with the unique Voglauer surface range. Made from renewable raw materials, this hard oil-wax combination based on plant oils creates the perfect conditions for a healthy living.

En cycle avec la nature

En tant que fabricant responsable de meubles en bois naturel, Voglauer a toujours mis un point d'honneur à n'utiliser que des matériaux naturels gérés durablement. C'est pourquoi seuls des bois issus de la sylviculture durable sont utilisés dans le processus de fabrication, ce qui permet à Voglauer de produire entièrement en cycle avec la nature.

Chaque arbre utilisé pour fabriquer nos meubles est garanti de repousser.

Les meubles Valpin ne séduisent pas seulement par leur caractère naturel mais aussi par leur design aux finitions parfaites, et leur qualité supérieure.

Pour que les surfaces naturelles de ces meubles soient particulièrement bien mises en valeur, elles sont traitées avec l'assortiment de produits d'entretien Voglauer. Fabriquée à partir de matières premières renouvelables, cette combinaison d'huile dure et de cire à base d'huiles végétales crée les conditions parfaites pour un habitat sain.



5 JAHRE GARANTIE
Autorisierter Fachhandelspartner
mit 5-Jahresgarantie

Highboards

Alle Elemente auch spiegelbildlich lieferbar

Bänke gepolstert



Schuhschränke

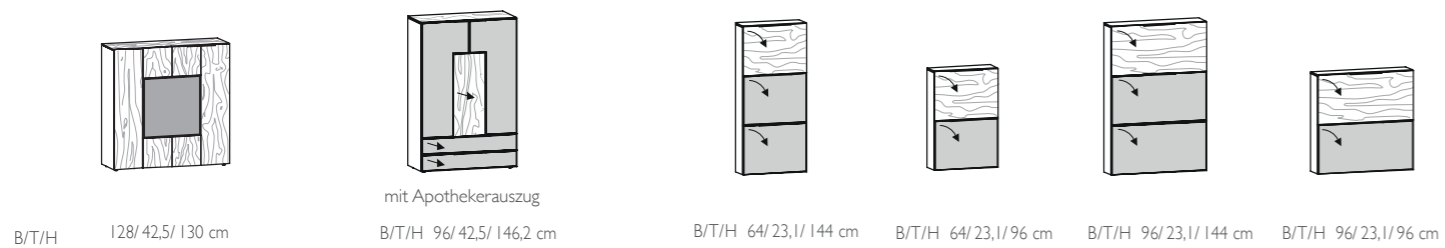

Spiegel Parsolglas

Garderobenständer

Stummer Diener mit Kubus

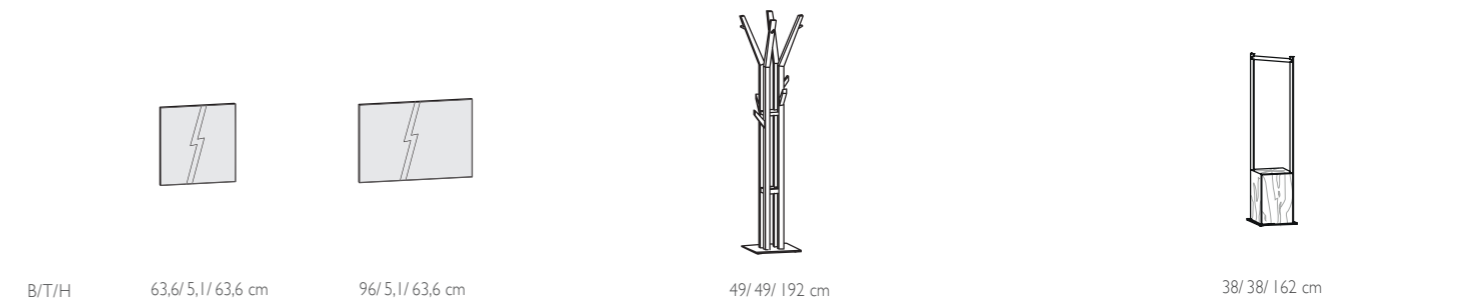

Dielenschränke



Garderobenpaneele

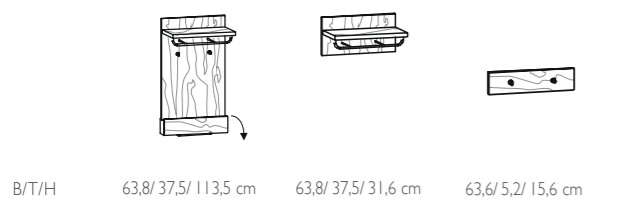
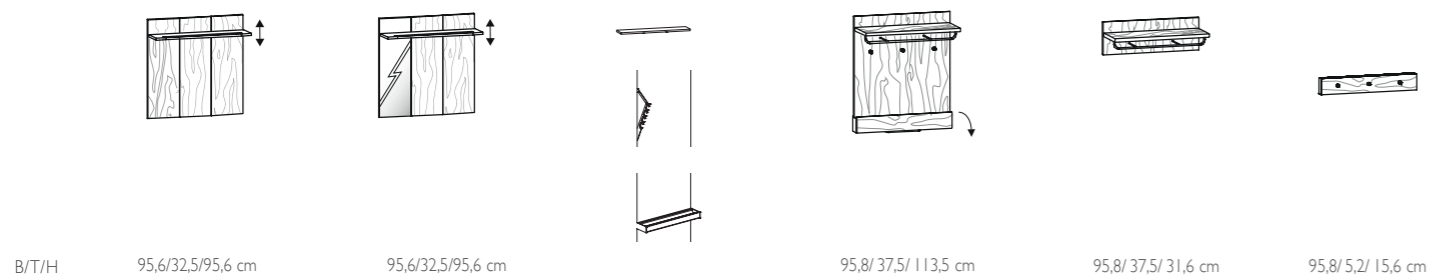

Die komplette Typenliste – alle Varianten und Typen – kann auf unserer Homepage heruntergeladen werden.

The complete type list can be downloaded on our homepage.

La liste complète de modèles peut être téléchargée sur notre site internet.

Dielenvorschläge

Dielenvorschlag 12
B/T/H 175 / 45 / 194 cm



Dielenvorschlag 14
B/T/H 175 / 42,5 / 177 cm

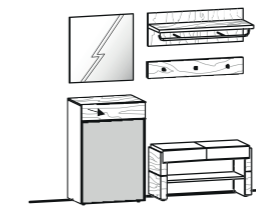

Dielenvorschlag 21
B/T/H 176 / 42,5 / 194cm

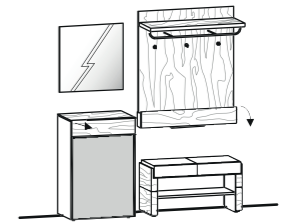

Dielenvorschlag 28
B/T/H 176 / 42,5 / 194cm

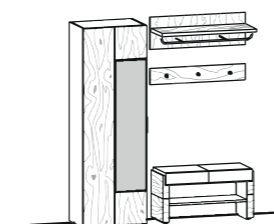

Dielenvorschlag 35
B/T/H 192 / 42,5 / 194cm

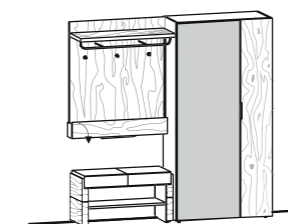

Dielenvorschlag 42
B/T/H 208 / 42,5 / 194 cm

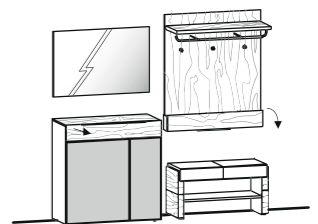

Weitere Informationen über Typen und Varianten erhalten Sie bei unserem Möbelhandelspartner in Ihrer Nähe! Zu finden im Internet auf www.voglauer.com unter der Rubrik: „Händler“.

For more information about our furniture, please visit our nearest partner! You will find the list of our partners on our website www.voglauer.com, in the "Retailer" section.

Pour plus d'information concernant nos meubles, n'hésitez pas à aller voir notre partenaire le plus proche de chez vous ! Vous trouverez la liste de nos partenaires sur notre site www.voglauer.com, dans la rubrique « Revendeurs ».

ALLE VOGLAUER MÖBELLINIEN



Wohnen/Speisen



Valpin



Vmontanara



Vrock living



Vtektura living



Schlafen



Valpin sleeping



Vmontanara sleeping



Vvaganto



Dielen



Valpin



Vmontanara



Vrock coming



Vtektura coming



Bad



Valpin bad



Vmontanara bad



Vquell



Vlineos



Möbelgütepasp
Gebrauchs- und Pflegeanweisung



Fordern Sie die gewünschten Folder telefonisch oder auf unserer Homepage an. Wir senden Ihnen diese gerne kostenlos zu.

Sie wollen mehr über unser Unternehmen oder unsere Produktlinien erfahren? Dann besuchen Sie uns im Internet unter www.voglauer.com



Abonnieren Sie uns auf unsere sozialen Medien. Hier werden Sie regelmäßig über aktuelle Entwicklungen und News rund um Voglauer informiert.

Voglauer Gschwandtner & Zwilling GmbH
Pichl 55, A-5441 Abtenau
Tel.: +43 (0) 6243 2700-0
office@voglauer.com | www.voglauer.com

Ihr Voglauer Einrichtungspartner: